

HCS-2

Hydro-X Pro

The Hydro-X Pro (HCS-2) is an upgraded main controller that features a 10.1-inch touch screen. The main controller HCS-2 comes standard with a 4-in-1 (Temp / Humidity / CO2 / Photocell) sensor. It is backward compatible with all current Hydro-X control & device modules and provides greater flexibility and much more advanced functions.



Connection

Daisy Chain Connection



The sensors and control modules (device stations) are connected to the HCS-2 with a standard RJ12 cable and RJ12 Y-splitters, making installation as simple as plug-and-play. The modules are "daisy-chained" together using the RJ12 cables allowing for flexible installation, and future expansion. To make installation even easier, you can also use the SPH-1 8-port hub instead of using the Y-splitters.

Remote Control

Web-based software



Besides the onboard user interface/touch-screen, the TrolMaster app will provide real-time data and user notifications from the HCS-2. The HCS-2 also offers a free web-based software program that allows remote control and monitoring through the internet with any desktop, laptop, smartphone or tablet. To access the online software, simply login with your app email and password at pro.trolmaster.com

Specifications

HCS-2

Input Voltage

Voltage 100-240V~, 50/60Hz

Display & Control

Size 10.1" LED Screen

Control Touch Screen Control

Language: English (International)

USB/micro-SD Save/Copy/Import/Export data

Working Environments

Temperature 32°-122°F (0-50°C)

Humidity ≤90%RH

Environment Setting

Temperature 40-100°F

Humidity 20-99%

CO2 300-2500PPM

Light Intensity 10-2000 PPFD

Package Dimensions

Size 14.96inch / 380mm(L) x 10.63inch / 270mm(W) x 3.35inch / 85mm(H)

Gross Weight 6.75lbs / 3.06kg

Product Capacity

Sensors Max 50pcs

Devices Max 50pcs

Light Channels 2pcs

Amount of Lights Unlimited

Package Contents

Hydro-X Pro (HCS-2) 1pc

MBS-PRO 1pc

Mouting Plate 1pc

4ft M12 Cable 1pc

Link Up

HCS-2

Other Control

There are other modules that can be used to control devices in different circumstances in accordance with user's need.

For instance, devices like fans or pumps can be controlled based on time rather than Temperature, Humidity, and CO2 with the Timer Control module the DSP-1.

The DCC-1, DSV-1 and the 4RS-1 Expander Station offer dual condition control, low voltage control and multiple device control respectively.

Other Sensor Alert

These 3 sensors: MBS-SD, WD-2, WCS-1, are used to detect smoke, water leakage and abnormal moisture level of medium. Warning alerts will be sent to users on the TrolMaster App when abnormal conditions are detected to alert them about potential problems before things get out of hand.

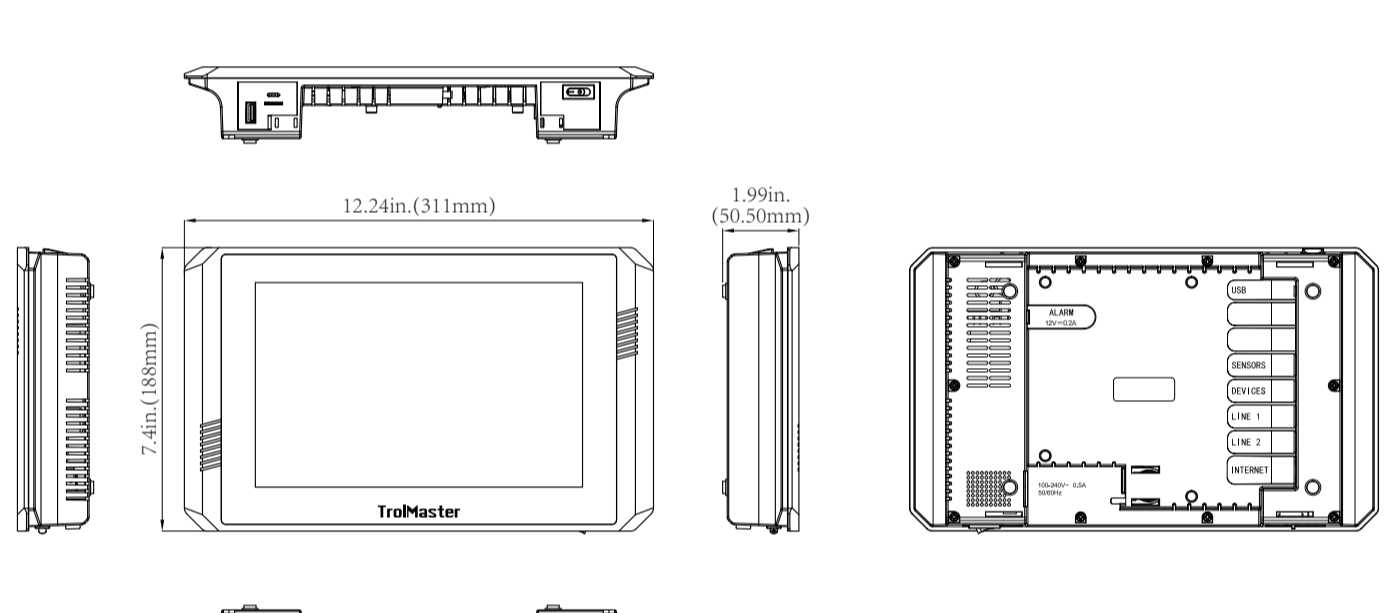
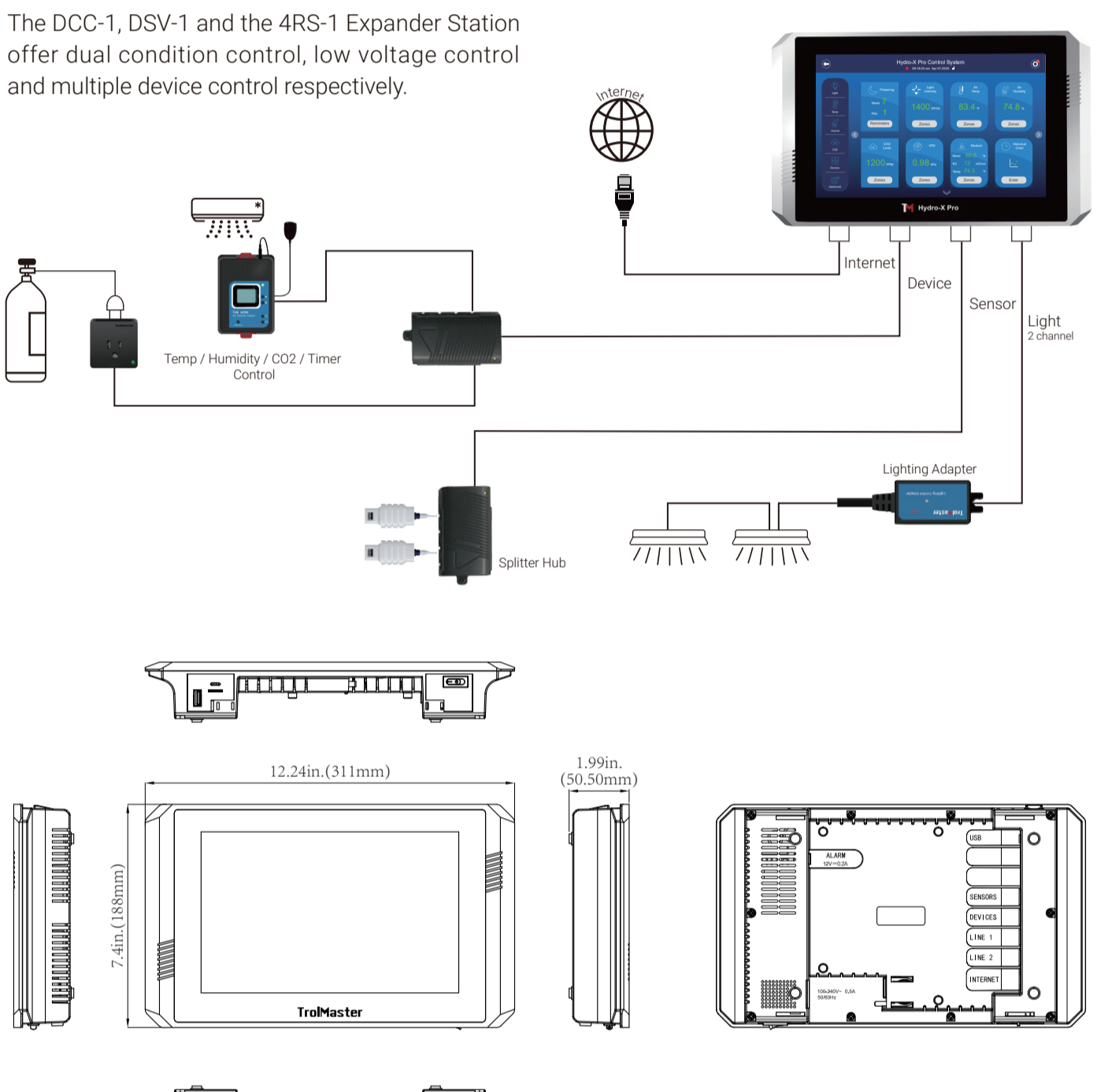

Hydro-X Pro

Unique Features

- Smoke Alarm Control**
 Device modules are now able to react if the MBS-SD smoke detectors are triggered by the presence of smoke. Users can now set up their Hydro-X Pro to shut off power to selected devices when smoke is detected.
- Customized Ramp Up/Down Environment Climate Control**
 Allows Temp & CO2 & Humidity & Light Parameters to be changed gradually and avoid instant drastic changes to better mimic the natural outdoor conditions.
- Multiple Sub-zone Control**
 Sub-Zones can be created to ensure a complete and balanced growing environment by allowing separate control on device groups by assigning specific sensors to control specific device modules.
- Cloud Effect**
 By simulating natural cloud movements, the HCS-2 integrates with ThinkGrow LEDs to mimic a natural outdoor-like environment, creating a stress-free environment for your plants and optimizing power efficacy.
- DLI (Daily Light Integral) Control and Monitoring**
 Can be used to calculate the exact amount of light needed based on the PPFD to enhance growth rates and to save energy.
- Spray Mode**
 Will automatically reduce the power to the lights, or turn lights off... lower fan speed or turn off equipment when foliar spraying, and then turn the equipment back on to the initial setting after a period of time.
- 4 Adjustable Spectrum**
 Experience unparalleled control in crafting your desired light recipes on ThinkGrow LEDs with adjustable UV, white, deep red, and far-red spectra.
- Calendar Control Presets & Customized Reminders**
 Allow users to "build" their own custom crop schedules and program reminders.
- Group Control**
 Effortlessly create customized lighting combinations for up to 10 groups of ThinkGrow LEDs on a single HCS-2 controller, with the flexibility to control each group's settings independently.
- Media Moisture & EC & PH & Temp Level**
 Percentage of water or nutrients within the growing medium can be monitored with the WCS-1 & 2 Water Sensor.
- Multiple Activation Conditions**
 Each plug-in module can be programmed with multiple conditions, allowing almost unlimited control options on the device modules.

Lighting Control

With Hydro-X System

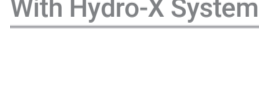

Light Control

The Hydro-X Pro can control almost all horticultural lighting systems (LED / HID) in the market using one of TrolMaster's LMA series of lighting adapters. Two separate lighting control channels allow users to control two different lighting systems with separate setpoints.

When used with Hydro-X Pro, the LMA-T can provide user's ultimate control over ThinkGrow LED (i.e. individual control on 4 different spectrums of the PLUS series), and allows users to adjust and control the light spectrum according to their individual needs.

MBS-PAR Sensor

The PAR sensor can be incorporated into the Hydro-X Pro system to provide a measurement of "PAR" (Photosynthetically Active Radiation). After entering the value of the desired amount of PPFD to HCS-2, the PPFD sensor will automatically increase or decrease the output level of the supplemental lighting systems to continuously maintain the exact lighting level (in terms of PPFD) selected.

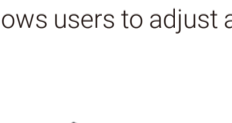

4-in-1 Sensor MBS-PRO

Temp/Humidity/CO2/Photocell

This sensor will measure air temperature, humidity, CO2 (PPM) and has a photocell to detect Day or Night operation, making it a perfect all-in-one environmental sensor. The sensor will detect the environmental parameters then send the collected data back to the Hydro-X Pro. By using different modules connected to the Hydro-X Pro system, the controller will then send signals to the modules and control those devices based on the environmental readings provided by the 4-in-1 sensor.

* Photocell sensor detects only the presence of light, not light intensity.

* All DS modules are universal and multi-purposed in the Hydro-X Pro system.

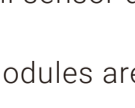

Temperature

Temperature can be regulated with the modules by controlling the temperature control devices.

For example, the ARS-1 can control mini-split AC, TS-2 can control HVAC system etc.

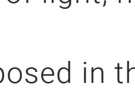

Humidity

Humidity can be regulated with the modules by controlling the humidity control devices.

For example, the HS-1 can control dehumidifiers, TSH-1 can control EC fans etc.



CO2

CO2 level can be regulated with the modules by controlling the CO2 control devices.

For example, the DSC-1 can control CO2 tank regulators and CO2 generators etc.

TrolMaster

Hydro-X PRO Control System

All DS modules are universal and multiple purposes in the Hydro-X Pro system
Included products: DST-1, DST-2, DSC-1, DSP-1, DSP-2, DSD-1, DSD-2, DSH-1, DSH-2, DSV-1

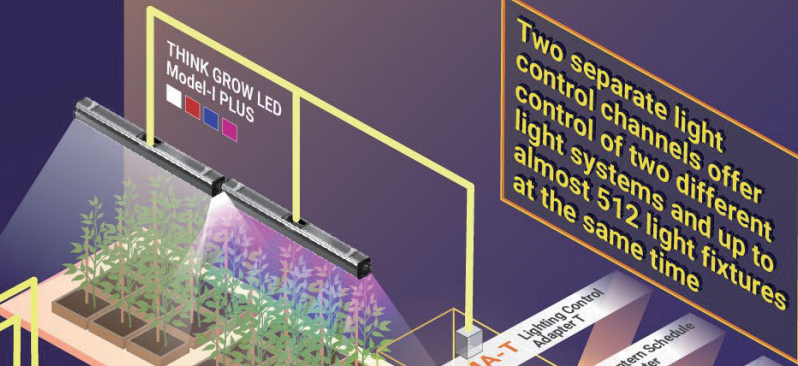

- Multiple sub-zones - within a single grow space
- Built-in Calendar - Presets to schedule crops recipe and reminder
- Customized Programming with graph - Construct graph to control setting on touch screen
- By allowing up to 50 sensors and up to 50 separate control modules

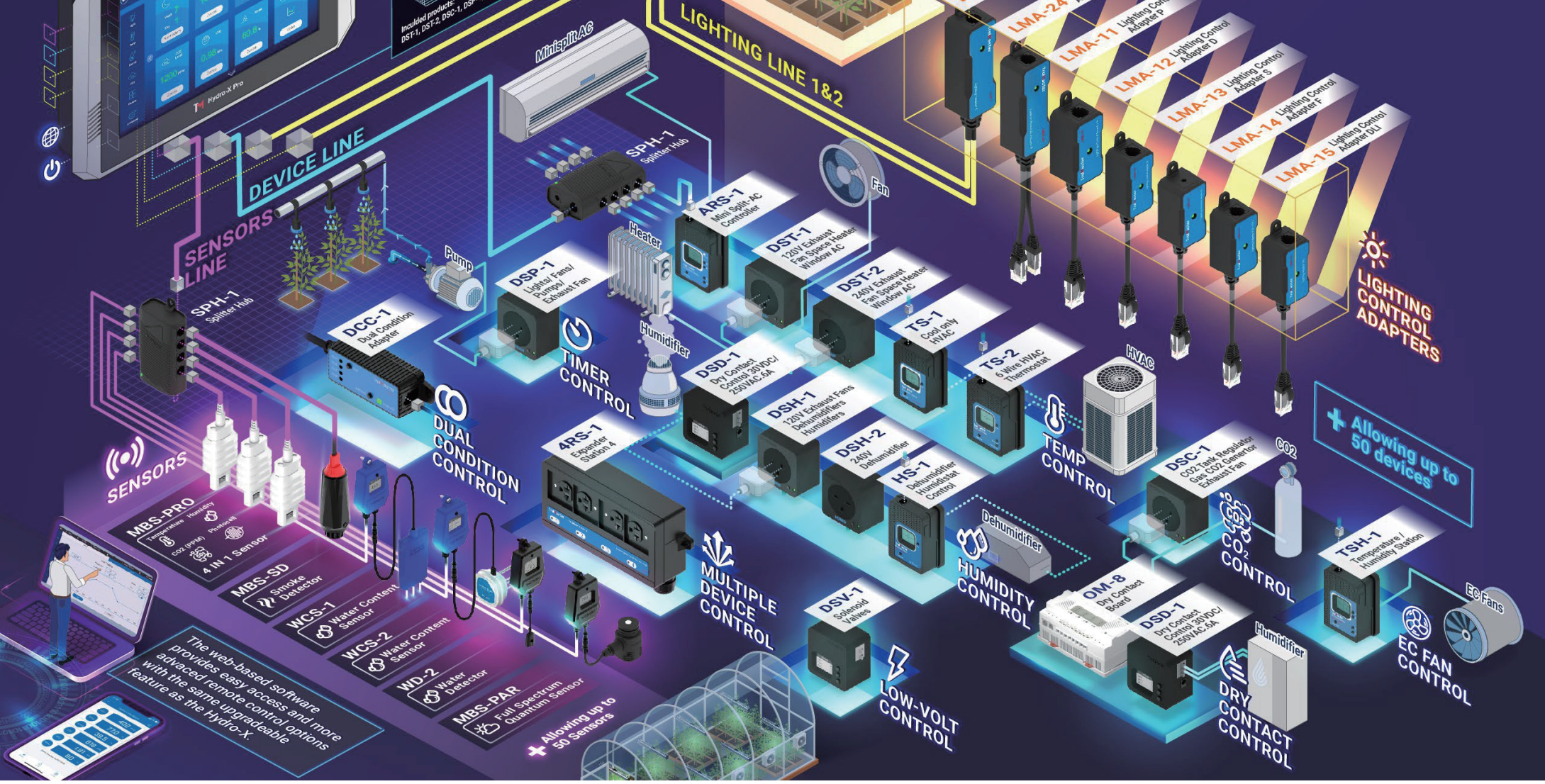

The web-based software provides easy access and more advanced remote control options with the same upgradeable feature as the Hydro-X